



APPLIANCE

TABLE OF CONTENTS

APPLIANCES-----	241
APPLIANCE TOUCH UP PAINT -----	242
BATH FANS & PARTS -----	250-251
BROILER PANS -----	245
DISHWASHER PARTS -----	250
DRIP PANS & TRIM RINGS -----	243
ICEMAKERS & PARTS -----	263, 246
HAND TRUCKS -----	242
LAUNDRY PARTS-----	251
RANGE & OVEN PARTS -	242, 243, 244, 245, 246
REFRIGERATOR PARTS -----	247
VENT-A-HOODS & PARTS -----	248-249

APPLIANCE



APPLIANCES

Unlimited Parts and Supplies carries a wide selection of Refrigerators, Electric and Gas Ranges and Dishwashers.



*Call 210.599.1118
and ask for a
quote on the make
and model of the
appliance you need.*

APPLIANCE





APPLIANCE ACCESSORIES

HAND TRUCK

RANGE RECEPTACLES

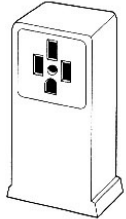

46605
4 WIRE 50 AMP
SURFACE MOUNT
\$11.00

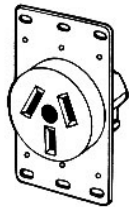

46606
3 WIRE 50 AMP
FLUSH MOUNT
\$4.25

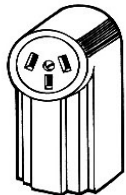

46607
3 WIRE 50 AMP
SURFACE MOUNT
\$9.95



46608
4 WIRE 50 AMP
RECESSED MOUNT
\$9.95

TOUCH-UP PAINT



41000
WHITE
41025
BISQUE

41020
ALMOND
\$3.25 EA.

APPLIANCE PAINT



41050
EPOXY
WHITE
\$6.10

41070
EPOXY
ALMOND
\$6.10

41050
EPOXY
BLACK
\$6.25



13776
• 550 LB. CAPACITY
• NON-RATCHET/HAND CRANK ONLY
• EQUIPED WITH 2 HEAVY DUTY, DOUBLE
STICHED, WEBBED STRAPS
CALL FOR PRICING

APPLIANCE

APPLIANCE ACCESSORIES

RANGE CORDS



46602
4' CORD
3 WIRE
50 AMP
\$14.95

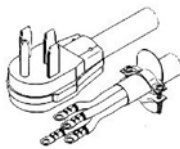

46604
4' CORD
4 WIRE
50 AMP
\$13.95

PIGTAIL CORD

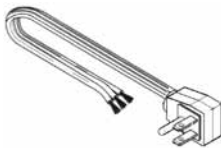

47605
3' CORD 115V
\$3.25

WALL PLATE

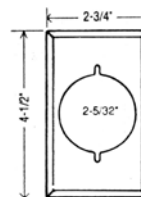

46401
CHROME COVER PLATE
USE WITH RANGE, DRYER
& POWER OUTLETS
\$1.99



DRIP PANS & TRIM RINGS

G.E./HOTPOINT



46300
DRIP PAN-8"
#5008B

\$15.72/12

46305
DRIP PAN-6"
#5016B

\$12.00/12

G.E./HOTPOINT



46345
TRIM RING-8"
#GT8B

\$23.40/12

46340
TRIM RING-6"
GT6B

\$24.60/12

G.F./HOTPOINT 1 PIECE/DFFP



46322
DRIP PAN-8"
#5011-8

\$33.00/12

46321
DRIP PAN-6"
#5010-6

\$30.00/12

G.E./HOTPOINT 1 PIECE/SHALLOW



46324
DRIP PAN-8"
#5076-8

\$22.56/12

46323
DRIP PAN-6"
#5075-6

\$19.80/12

OLD STYLE WHIRLPOOL/ KENMORE



46320
DRIP PAN-8"
#770-8B

\$20.40/12

46325
DRIP PAN-6"
#771-6B

\$17.76/12

NEW STYLE WHIRLPOOL



46352
DRIP PAN-8"
#750-8

\$24.60/12

46351
DRIP PAN-6"
#751-6

\$21.00/12

WESTINGHOUSE 1 PIECE



46318
DRIP PAN-8"
#223-8

\$49.20/12

46317
DRIP PAN-6"
#221-6

\$41.40/12

FRIGIDAIRE/WESTINGHOUSE



46310
DRIP PAN-8" #5048B USE W/
FRIGIDAIRE RINGS 46335 & 46350

\$16.20/12

46315
DRIP PAN-6" #5056B USE W/
FRIGIDAIRE RINGS 46330 & 46347

\$15.00/12

FRIGIDAIRE



46335
TRIM RING-8"
#FT8B

\$35.88/12

46330
TRIM RING-6"
#FT6B

\$34.20/12

WESTINGHOUSE



46350
TRIM RING-8"
#WT8B

\$33.00/12

46347
TRIM RING-6"
#WT6B

\$30.00/12

APPLIANCE



G.E. SURFACE ELEMENTS

CALL WITH YOUR MAKE & MODEL NUMBER SO WE CAN FIND THE CORRECT ELEMENT. WE HAVE MANY MORE ELEMENTS AVAILABLE .IF IT IS MADE ---- WE CAN GET IT FOR YOU!



46706
WB30X354
8" WIRE IN

\$29.00



46709
WB30X341
8" WIRE IN

\$33.00



46711
WB30X218
6" PLUG IN USE WITH
TERM BLOCK #46723

\$17.50



46751
WB30X359
6" WIRE IN

\$19.00



46748
WB30X5071 OR WB30M1
6" PLUG IN USE WITH
TERM BLOCK #46728

\$21.25

46707
WB30X356
6" WIRE IN

\$23.50

46710
WB30X342
6" WIRE IN

\$26.95

46712
WB30X219
8" PLUG IN USE WITH
TERM BLOCK #46723

\$23.00

46752
WB30X348
8" WIRE IN

\$23.00

46749
WB30X5072 OR WB30M2
8" PLUG IN USE WITH
TERM BLOCK #46728

\$24.00

G.E. OVEN ELEMENTS

CALL WITH YOUR MAKE & MODEL NUMBER SO WE CAN FIND THE CORRECT ELEMENT. WE HAVE MANY MORE ELEMENTS AVAILABLE .IF IT IS MADE ---- WE CAN GET IT FOR YOU!

APPLIANCE

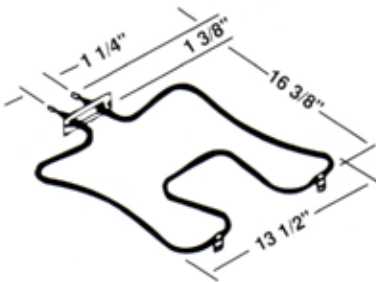

46760
BAKE ELEMENT
WB44X5043
\$15.00

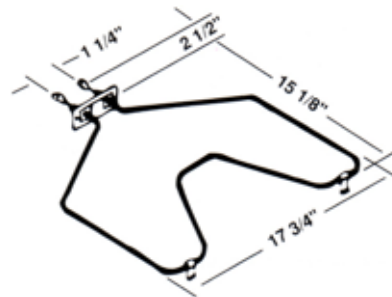

46775
BAKE ELEMENT
WB44X5082
\$13.00

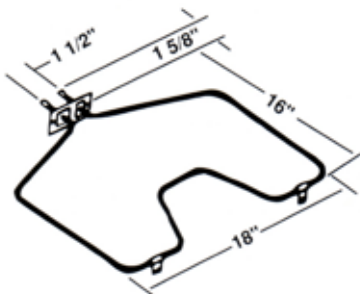

46785
BAKE ELEMENT
WB44X5099
\$13.00

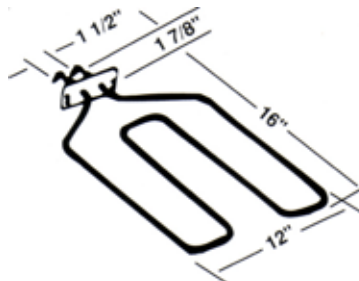

46753
BROIL ELEMENT
WB44X5074
\$13.50



RANGE PARTS

CALL WITH YOUR MAKE & MODEL NUMBER SO WE CAN FIND THE CORRECT PART. WE HAVE MANY MORE ELEMENTS AVAILABLE .IF IT IS MADE ---- WE CAN GET IT FOR YOU!



46365
BROILER PAN
PORCELAIN
\$15.85

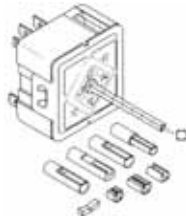

46717
SURFACE INFINITE
SWITCH - WB21X5243
\$23.50



46675
SURFACE ELEMENT
6" PLUG-IN
#660532/EP12YA
\$8.50

46676
SURFACE ELEMENT
8" PLUG-IN
#660533/EP21YA
\$10.25



46599
INDICATOR LGHT
WB2X1608
\$25.00



46600
OVEN LIGHT JEWEL
WB 25X65
\$11.95

OVEN ELEMENTS

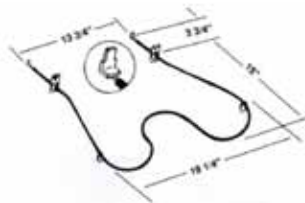

46616
#865940/CH775
\$22.00



46618
#308180/CH4836
\$23.00

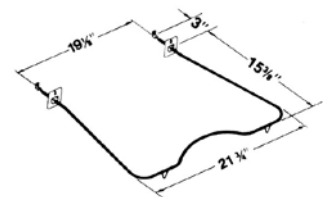

46627
#326793/CH2860
\$21.00

APPLIANCE

SURFACE TERMINAL BLOCKS

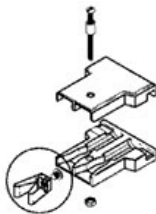

46723
WB17X5051
USE WITH #46711 & #46712
\$10.25

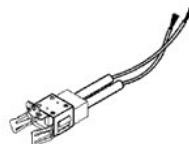

46728
WB17X5113
USE WITH #46748 & #46749
\$16.95



46603
WHIRLPOOL #330031 OR
FRIGIDAIRE #5303935058
\$5.95



UNIVERSAL RANGE PARTS



46677
SURFACE
KNOB KIT
GAS #126

\$16.50/pk.



46681
THERMOSTAT
KNOB
GAS #118

\$4.95/ea.

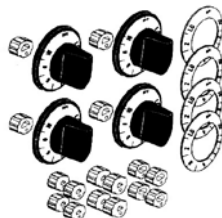

46678
SURFACE
KNOB KIT
ELECTRIC #108

\$16.50/pk.



46679
SURFACE &
THERMOSTAT KNOB
ELECTRIC #100

\$5.95/ea.



46670
OVEN KNOB KIT
MAGIC CHEF
#12500021

\$68.00/pk.

RANGE CORDS



46602
4' CORD
3 WIRE - 50 AMP
\$14.95



46605
4 WIRE 50 AMP
SURFACE MOUNT
\$11.00

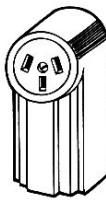

46607
3 WIRE 50 AMP
SURFACE MOUNT
\$9.95



46601
OVEN
THERMOMETER
\$4.95

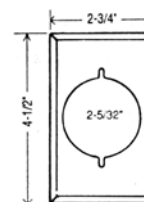

46401
CHROME COVER WALL PLATE
USE WITH RANGE, DRYER
& POWER OUTLETS
\$1.99

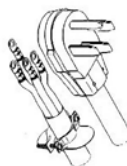

46604
4' CORD
4 WIRE - 50 AMP
\$13.95



46606
3 WIRE 50 AMP
FLUSH MOUNT
\$4.25



46608
4 WIRE 50 AMP
RECESSED MOUNT
\$9.95

ICEMAKERS & PARTS



46485
IM6
GE
\$105.00



46482
REPLACEMENT AUTOMATIC
ICEMAKER KIT
WPL 4317943
\$89.00



46484
WATER VALVE
GE
WR57X77
\$31.00



46487
WATER VALVE
WHIRLPOOL
4318047
\$16.00



46488
INLINE WATER FILTER
1/4" MALE X
1/4" COMP.
\$14.95



46420
TUBING KIT 1/4 X 25'
POLY TUBE, VALVE, UNION,
INSERTS & SLEEVE
\$8.00



46421
TUBING KIT 1/4" X 10'
STAINLESS STEEL LINE & 1/4"
X 1/4" BRASS FITTINGS
\$12.75

APPLIANCE



REFRIGERATOR PARTS

EVAPORATOR MOTORS

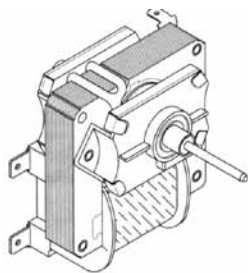

46940

GE
WR60X10141

\$55.00

46995

GE
WR60X162

\$35.00



46837

WPL 482731
EVAPORATOR
FAN MOTOR

\$32.00

CONDENSER MOTOR



46991

GE
WR60X177

\$33.00

46990

GE
WX4X988

\$19.50

FAN BLADE

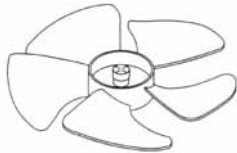

46996

GE
WR60X114

\$10.50

COVERS



47126

CRISPER COVER
GE WR32X1094
GE WR32X10398

\$55.00

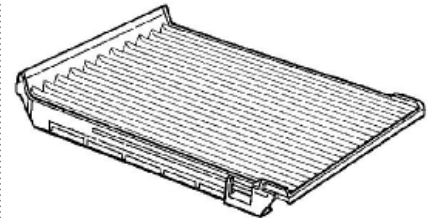

47129

CRISPER
COVER
GE WR32X5206

\$53.00

DOOR GASKETS



CALL WITH YOUR MAKE & MODEL
NUMBER SO WE CAN FIND THE
CORRECT PART. IF IT IS MADE
WE CAN GET IT FOR YOU!

DEFROST TIMERS

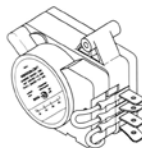

46975

WR9X480

\$14.99



46845

WPL 482493

\$12.60

BULB



37000

40A15 40 WATT

\$1.25

ICE TRAY

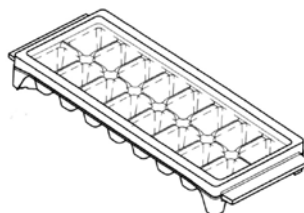

46480

IVORY

\$3.80/2

HARD START KIT



11812

3 IN 1

\$15.75

APPLIANCE



VENT-A-HOODS & ACCESSORIES

DUCTED VENT-A-HOODS

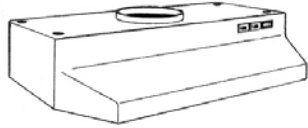
	47539 24" WHITE \$48.00	47547 30" WHITE \$48.00	47559 36" ALMOND \$49.00
	47540 24" ALMOND \$48.00	47545 30" ALMOND \$48.00	
	47556 7" ROUND DUCT 30" WHITE \$41.50		

DUCTLESS VENT-A-HOODS

	47555 30" WHITE \$43.95	47557 36" WHITE \$49.00
	47551 30" ALMOND \$43.50	47550 30" BISQUE \$43.50

ALUMINUM FILTER WITH LENS



60694
10 13/16 INCH X 11 13/16 INCH
X 1/2 INCH
FITS BROAN & NAUTILUS
\$9.50

60678
9 INCH X 12 INCH X 5/16 INCH
LENS SIZE 4 INCH X 9 INCH
FITS BROAN
\$11.71

V60696
11-7/16" X 11-13/16" X 3/8"
FITS WHIRLPOOL
\$17.69

DOME SHAPED ALUMINUM FILTER



V60683
10-1/2" ROUND X 3/32" X 3-1/4"
FITS BROAN, GE, NAUTILUS
\$9.09

ROUND SHAPED ALUMINUM FILTER



V60688
ROUND SHAPED ALUMINUM FILTER
9 1/2 INCH ROUND X 3/32 INCH WITH GROMMET
FITS BROAN, AUBREY, MIAMI-CAREY
\$6.86

ACTIVATED CARBON ALUMINUM FILTER

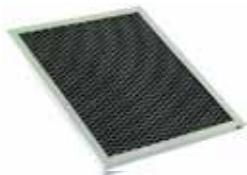

60669
8" X 9-1/2" X 3/32"
AIRE-CARE, AUBREY, PENNYS, RANGEMASTER
\$7.85

POLYSORB CARBON FILTER

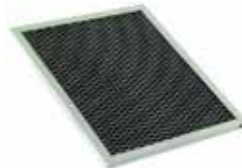

V60677 **V60691**
8-1/4" X 11-1/4" X 3/8" 8-15/16" X 8-15/16" X 3/8"
FITS BROAN FITS BROAN
\$11.64 **\$10.53**

ACTIVATED CARBON FILTER

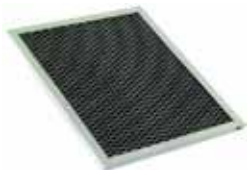

V60670
8" X 9-1/2" X 3/8"
FITS AIRE-CARE, AUBREY, CHEFAIRE,
PENNYS, RANGEMASTER
\$10.53

60673
8-3/4" X 10-1/2" X 3/8"
FITS BROAN
\$10.75

V60661
7" X 7-1/2" X 3/8"
FITS NUTONE
\$6.80

V60662
8" X 11" X 3/8"
FITS NUTONE
\$7.21

ALL FILTERS ARE SOLD IN PACKS OF 10 AND PRICED INDIVIDUALLY



VENT-A-HOODS & ACCESSORIES

ALUMINUM FILTER



THESE FILTERS ARE SOLD IN PACKS OF 10 AND PRICED INDIVIDUALLY

<p>V60667 7 1/4" X 9 1/2" X 3/32" FITS NUTONE, CALORIC, GE, WHIRLPOOL</p> <p>\$7.78</p>	<p>V60668 8" X 11" X 3/8" FITS NUTONE</p> <p>\$8.25</p>	<p>V60671 8 1/4" X 11 1/4" X 3/8" FITS WHIRLPOOL</p> <p>\$8.57</p>
<p>V60674 8 15/16" X 8 15/16" X 3/8" FITS NUTONE, MERCURY</p> <p>\$7.78</p>	<p>V60675 8" X 9 1/2" X 3/8" FITS NUTONE, MERCURY</p> <p>\$7.78</p>	<p>V60676 8 3/4" X 10 1/2" X 3/8" FITS BROAN</p> <p>\$8.20</p>
<p>V60679 9 1/2" X 11 3/4" X 3/8" FITS BROAN</p> <p>\$7.27</p>	<p>V60680 8 7/16" X 11 1/4" X 3/8" FITS WHIRLPOOL, MIAMI CAREY, BROAN, NUTONE</p> <p>\$7.27</p>	<p>V60681 8 5/8" X 11" X 3/8" FITS BROAN</p> <p>\$7.78</p>
<p>V60684 10 7/16" X 11 7/16" X 3/8" FITS GE, HOTPOINT</p> <p>\$9.37</p>		<p>V60660 10" X 11" X 1/8" FITS BROAN, MIAMI CAREY</p> <p>\$6.34</p>

LIGHT LENS

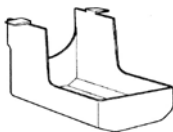

47593
BROAN #BP43
FITS OUR PART
NUMBERS 47555 & 47550

\$8.45



SOLD INDIVIDUALLY

47591
BROAN #41F NON-DUCTED
8 3/4" X 10 1/2" FITS OUR PART NUMBERS 47555 & 47550

\$10.25

47694
BROAN #BP29 DUCTED
FITS OUR PART NUMBER 47556

\$5.75

APPLIANCE

SWITCHES

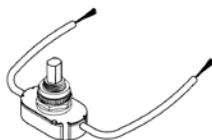

47565
PUSH
1 SPEED

\$2.65

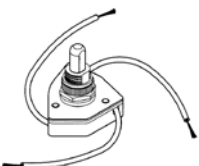

47566
ROTARY
2 SPEED

\$3.60



47560
TURN SWITCH
ONN/OFF

\$2.30

SPLASHGUARD

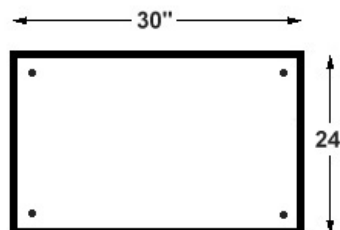

47570
WHITE/ALMOND
REVERSIBLE

\$21.95



DISHWASHER PARTS

PUMP & MOTOR

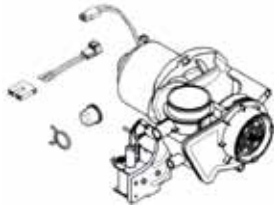

46075
GE WD26X10013
REPLACES WR26X10007
\$126.00

WATER VALVE

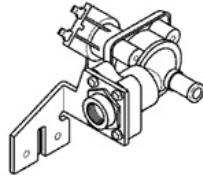

46077
GE WD15X93
\$22.00

ELBOWS

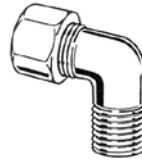

46110
3/8" C X 3/8" MIP
\$2.50



46111
3/8" C X 1 1/2" FIP
RPL. WHIRLPOOL® W10273460
\$5.25

SUPPLY LINE



51479
3/8" C X 3/8" C X 60"
W/3/8" C X 3/8" MIP ELBOW
STAINLESS STEEL

\$9.50

51480
3/8" C X 3/8" C X 72"
W/3/8" C X 3/8" MIP ELBOW
STAINLESS STEEL

\$10.25

PIGTAIL CORD

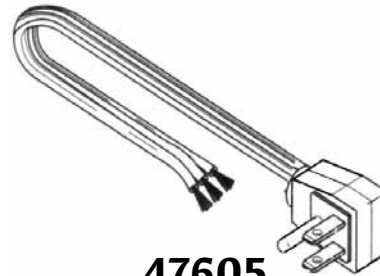

47605
3' 115V
\$3.25

APPLIANCE

BATH FANS & PARTS

EXHAUST FAN

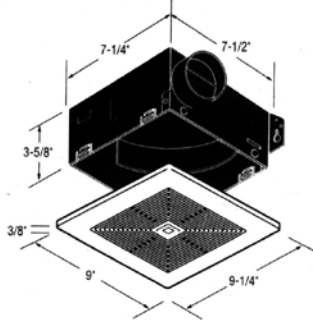

17355
#688 - 50 CFM
3" ROUND DUCT
CEILING OR WALL MOUNT
\$19.50

EXHAUST FAN WITH LIGHT

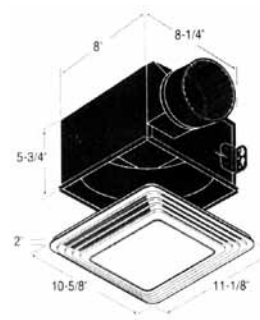

17360
#678
50 CFM TYPE IC
REQUIRES 100 WATT BULB
\$45.75

EXHAUST FAN WITH HEATER & LIGHT

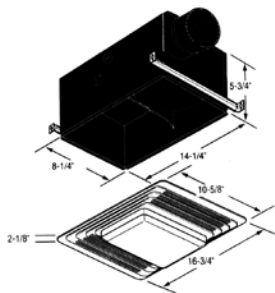

17350
#655 - 70 CFM
4" ROUND DUCT - 1300 WATT HEATER
USES 100 WATT BULB



\$102.00



BATH FANS & PARTS

BATH FAN GRILLES & LIGHT LENS



17363
METAL GRILLE - 10 1/4" X
10 1/4"
FITS BROAN #660, #662,
#664, #665, #666, #668
FITS MOST OTHERS

\$15.60

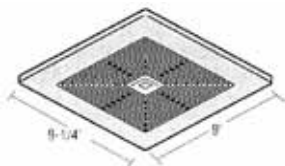

17361
GRILLE
9" X 9 1/4"
FITS BROAN #688 & #671
TORSION SPRING
MOUNTED

\$7.25



17362
LIGHT LENS - 6 7/8" X 7 7/8"
FITS BROAN #655A, 655B, 656A, 656B, 657A, 657B, 659A, 659B, 659C,
678A, 678B, 678C, 678D, 679A, 679B, 679FL-A, 695A, 695B, 695C, 696A,
696B, 696C
ALSO FITS MANY FASCO, NAUTILUS, SEARS & OTHERS
SNAPS IN PLACE

\$11.00

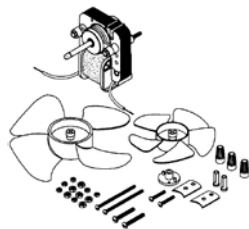

UTILITY MOTORS

47510
EM670
1 SPEED

\$11.95

47515
EM673
2 SPEED

\$16.00

LAUNDRY PARTS

DRYER VENT HOODS, PIPES & HOSES



46391
FIRE RESISTANT
FLEXIBLE, METALLIC
4" X 8'

\$9.00

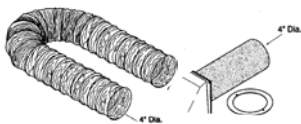

46410
HOOD, PIPE &
5' ALUMINUM HOSE
WITH BIRD GUARD

\$9.00

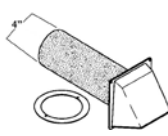

46415
HOOD & PIPE
WITH BIRD
GUARD

\$4.00

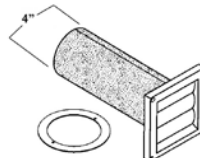

46417
LOUVERED
HOOD
& PIPE

\$3.25

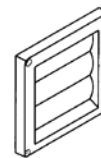

46416
LOUVERED
HOOD

\$3.00



46418
VENT HOOD
BIRD GUARD

\$3.95

APPLIANCE

WASHER FILL HOSE



47600
4 FT
1-RED/1-HOT
\$10.25/SET

DRYER CORD



46380
4' 3 WIRE
30 AMP
\$6.95

DRYER RECEPTACLES



46400
30 AMP
SURFACE MOUNT
\$4.50



46405
30 AMP
RECESSED MOUNT
\$7.25

DRYER VENT HOSE CLAMPS

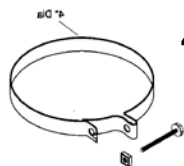

46395
PLASTIC
\$0.60

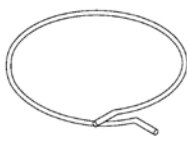

46396
METAL
SPRING TENSION
\$0.50

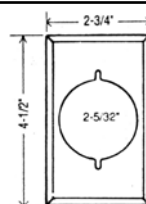

WALL PLATE

46401
CHROME COVER PLATE USE WITH
RANGE, DRYER & POWER OUTLETS
\$1.99

